

IEG1-34919-8-C

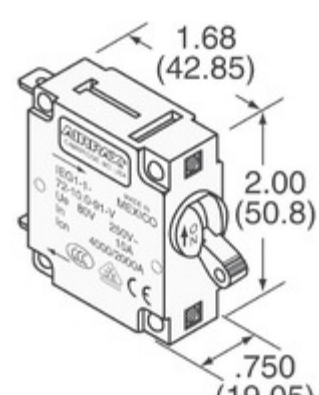

Obrázky jsou pouze orientační.
Podrobné informace o produktu naleznete v části Technické údaje produktu.

Koupit IEG1-34919-8-C s důvěrou od Component-World.HK, 1 rok záruka



Part Number: [IEG1-34919-8-C](#)

Výrobce: [Sensata Technologies, Airpax](#)

Popis: CIR BRKR MAG-HYDR LEVER

Datový list: [IEG, IUG, JEG, CEG, LEG Series Datasheet](#)

RoHS Status: Bez olova / V souladu RoHS

Ship From: Hong Kong

Shipment Way: DHL/Fedex/TNT/UPS/EMS

[Request For Quotation](#)













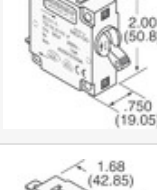
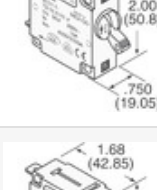
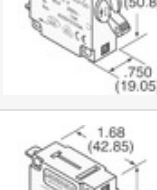
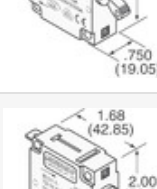
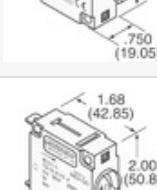

PARAMETR PRODUKTU

Part Number	IEG1-34919-8-C	Výrobce	Sensata Technologies, Airpax
Popis	CIR BRKR MAG-HYDR LEVER	Stav volného vedení / RoHS	Bez olova / V souladu RoHS
Dostupné množství	2342 pcs	Datový list	IAG,IUG,JEG,CEG,LEG Series Datasheet
Kategorie	Ochrana obvodu	Série	IEG
Počet pólu	1	Typ montáže	Panel Mount
Úroveň citlivosti na vlhkost (MSL)	1 (Unlimited)	Výrobní standardní doba výroby	6 Weeks
Stav volného vedení / RoHS	Lead free / RoHS Compliant	Osvětlení napětí (nominální)	-
Osvětlení	-	Jmenovitá hodnota proudu	-
Breaker Typ	Magnetic (Hydraulic Delay)	Pohon Type	Lever

Component-World.com je spolehlivý distributor elektronických součástek. Specializujeme se na všechny elektronické komponenty řady Sensata Technologies, Airpax. Máme 2342 kusy Sensata Technologies, Airpax IEG1-34919-8-C na skladě dostupných. Vyžádejte si citát z distributora součástí elektroniky na Component-World.com, náš prodejní tým vás bude kontaktovat do 24 hodin.

RFQ Email: info@Components-World.com

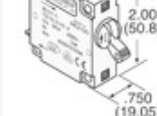
SOUVISEJÍCÍ PRODUKTY

	Část#: IEG1-34804-5A-V	Výrobci: Sensata Technologies, Airpax	Dotaz
	Část#: IEG1-35628-10-V	Výrobci: Sensata Technologies, Airpax	Dotaz
	Část#: IEG1-35592-1-V	Výrobci: Sensata Technologies, Airpax	Dotaz
	Část#: IEG1-35592-2-V	Výrobci: Sensata Technologies, Airpax	Dotaz
	Část#: IEG1-35628-15-V	Výrobci: Sensata Technologies, Airpax	Dotaz
	Část#: IEG1-34978-3-V	Výrobci: Sensata Technologies, Airpax	Dotaz
	Část#: IEG1-34804-3A-V	Výrobci: Sensata Technologies, Airpax	Dotaz
	Část#: IEG1-34919-6-C	Výrobci: Sensata Technologies, Airpax	Dotaz
	Část#: IEG1-34863-20-V	Výrobci: Sensata Technologies, Airpax	Dotaz
	Část#: IEG1-35374-1-V	Výrobci: Sensata Technologies, Airpax	Dotaz
	Část#: IEG1-34804-4A-V	Výrobci: Sensata Technologies, Airpax	Dotaz
	Část#: IEG1-34919-15-C	Výrobci: Sensata Technologies, Airpax	Dotaz
	Část#: IEG1-34968-2-V	Výrobci: Sensata Technologies, Airpax	Dotaz
	Část#: IEG1-34919-7-C	Výrobci: Sensata Technologies, Airpax	Dotaz
	Část#: IEG1-35628-1-V	Výrobci: Sensata Technologies, Airpax	Dotaz
	Část#: IEG1-34968-1-V	Výrobci: Sensata Technologies, Airpax	Dotaz
	Část#: IEG1-34919-13-C	Výrobci: Sensata Technologies, Airpax	Dotaz
	Část#: IEG1-35374-2-V	Výrobci: Sensata Technologies, Airpax	Dotaz
	Část#: IEG1-34919-5-C	Výrobci: Sensata Technologies, Airpax	Dotaz
	Část#: IEG1-34863-15-V	Výrobci: Sensata Technologies, Airpax	Dotaz

Související klíčová slova pro IEG1-34919-8-C

Sensata Technologies, Airpax IEG1-34919-8-C.	IEG1-34919-8-C distributor	IEG1-34919-8-C dodavatel	IEG1-34919-8-C Cena
IEG1-34919-8-C Stáhnout datasheet.	IEG1-34919-8-C Datasheet.	IEG1-34919-8-C Stock.	koupit IEG1-34919-8-C.
Sensata Technologies, Airpax IEG1-34919-8-C.	Sensata Technologies/Airpax IEG1-34919-8-C.		